



US00D356229S

**United States Patent** [19]  
**Stein**

[11] **Patent Number: Des. 356,229**  
[45] **Date of Patent: \*\* Mar. 14, 1995**

[54] **PEDESTAL MOUNTED DRINKING FOUNTAIN**

[75] Inventor: **Matthew I. Stein**, Truckee, Calif.

[73] Assignee: **Haws Company**, Sparks, Nebr.

[\*\*] Term: **14 Years**

[21] Appl. No.: **9,656**

[22] Filed: **Jun. 21, 1993**

[52] U.S. Cl. .... **D7/304; D7/300**

[58] Field of Search ..... **D7/300, 304, 213, 305, D7/306; D23/201; 239/24, 28, 29, 29.5**

[56] **References Cited**

**U.S. PATENT DOCUMENTS**

D. 217,401	4/1970	Lazzo, III	.....	D7/304
D. 223,782	6/1972	Wright	.....	D7/304
D. 343,330	1/1994	Windenburg et al.	.....	D7/304
3,734,408	5/1973	Wright	.....	239/29

**OTHER PUBLICATIONS**

Oasis Water Cooler, Oasis Catalog p. 7.

*Primary Examiner*—Alan P. Douglas

*Assistant Examiner*—M. N. Pandozzi

*Attorney, Agent, or Firm*—Kelly Bauersfeld & Lowry

[57] **CLAIM**

The ornamental design for a pedestal mounted drinking fountain, as shown and described.

**DESCRIPTION**

FIG. 1 is a perspective view showing the top, front and right sides of a pedestal mounted drinking fountain embodying my new design;  
 FIG. 2 is a right side elevational view thereof;  
 FIG. 3 is a rear elevational view thereof;  
 FIG. 4 is a front elevational view thereof;  
 FIG. 5 is a left side elevational view thereof;  
 FIG. 6 is a top plan view thereof;  
 FIG. 7 is a bottom plan view thereof;  
 FIG. 8 is a perspective view of a pedestal mounted drinking fountain, showing a second embodiment of my new design;  
 FIG. 9 is a perspective view illustrating the top, rear and left sides of the embodiment of FIG. 8;  
 FIG. 10 is a right side elevational view of the embodiment of FIG. 8;  
 FIG. 11 is a rear elevational view of the embodiment of FIG. 8;  
 FIG. 12 is a front elevational view of the embodiment of FIG. 8;  
 FIG. 13 is a left side elevational view of the embodiment of FIG. 8;  
 FIG. 14 is a top plan view of the embodiment of FIG. 8; and,  
 FIG. 15 is a bottom plan view of the embodiment of FIG. 8.

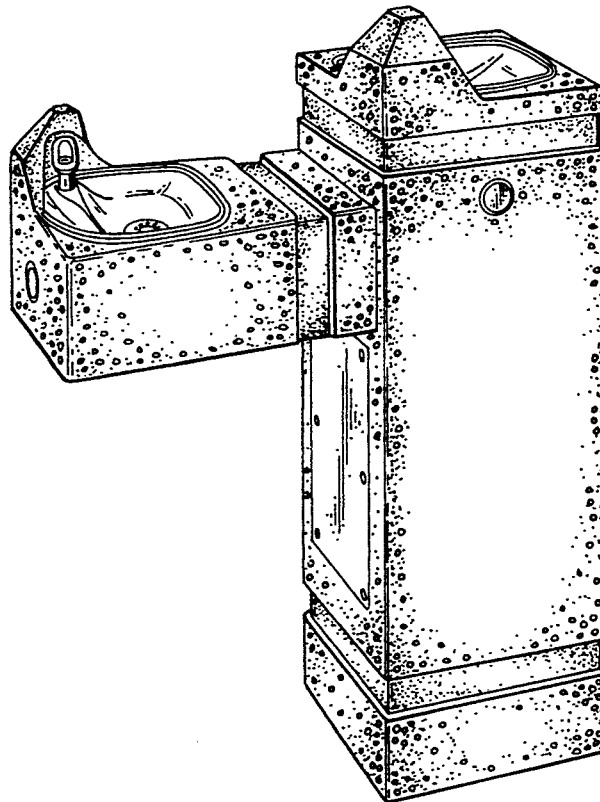

FIG. 1

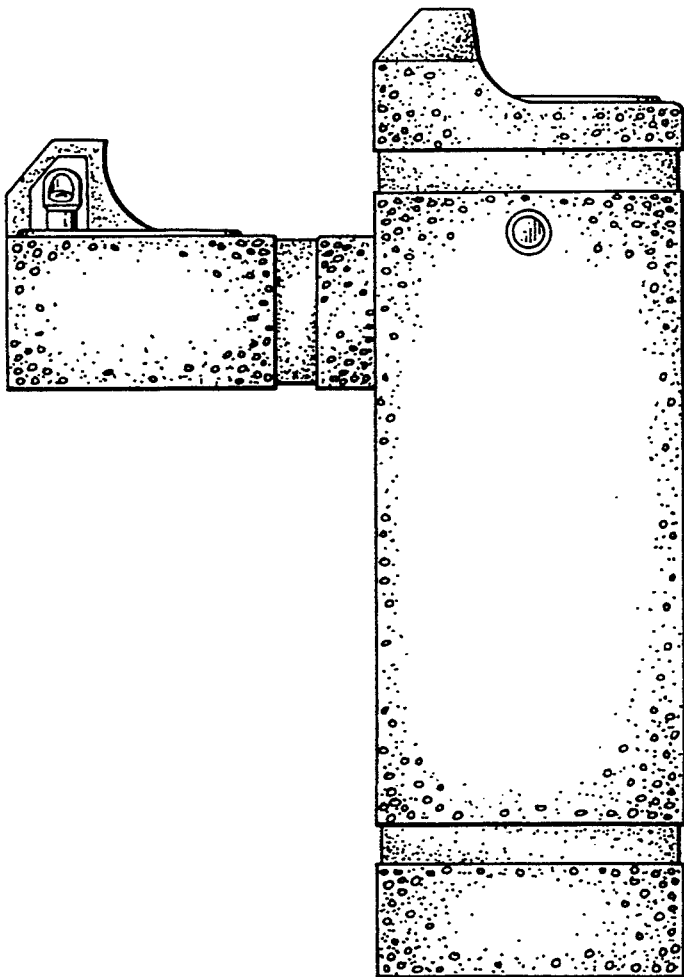
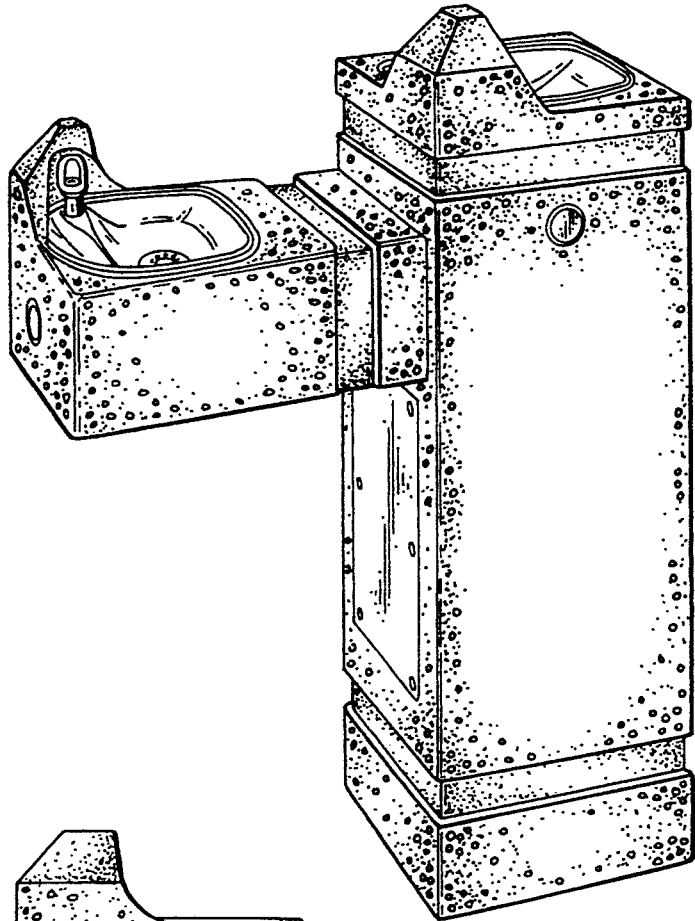

FIG. 2

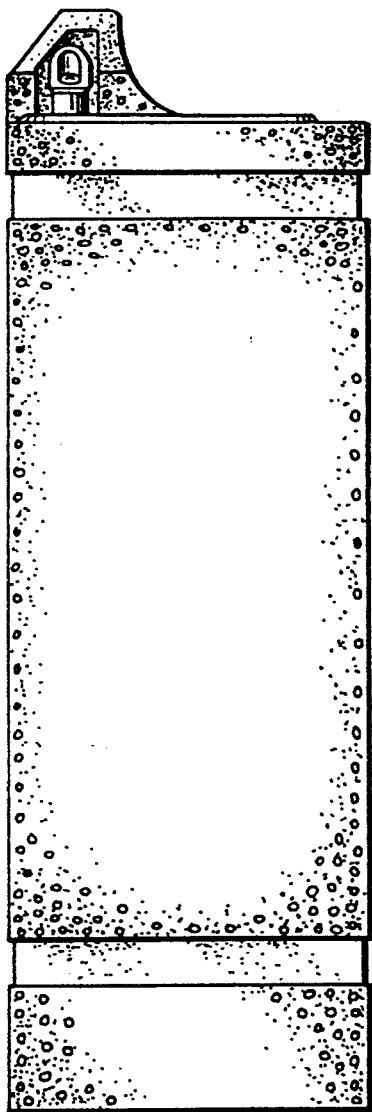

FIG. 3

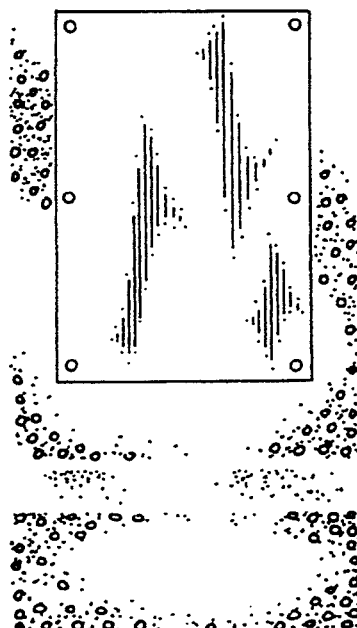
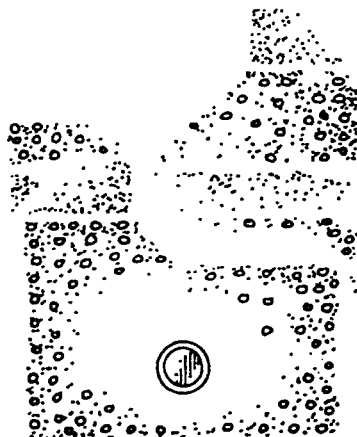

FIG. 4

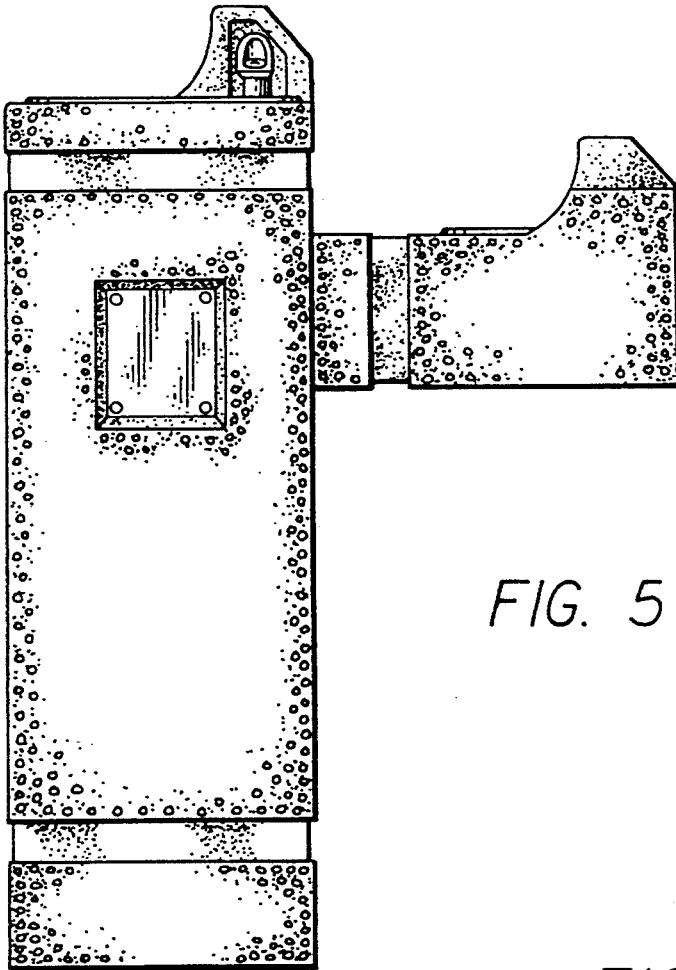

FIG. 5

FIG. 6

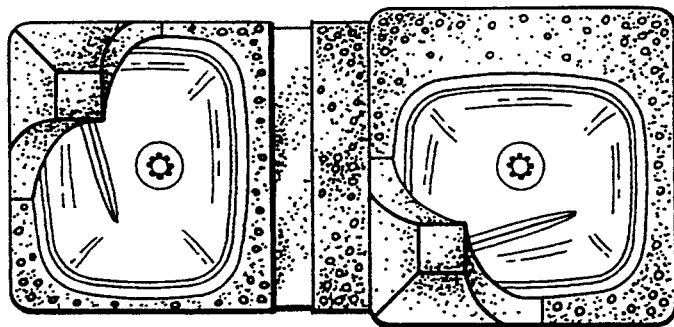

FIG. 7

FIG. 8

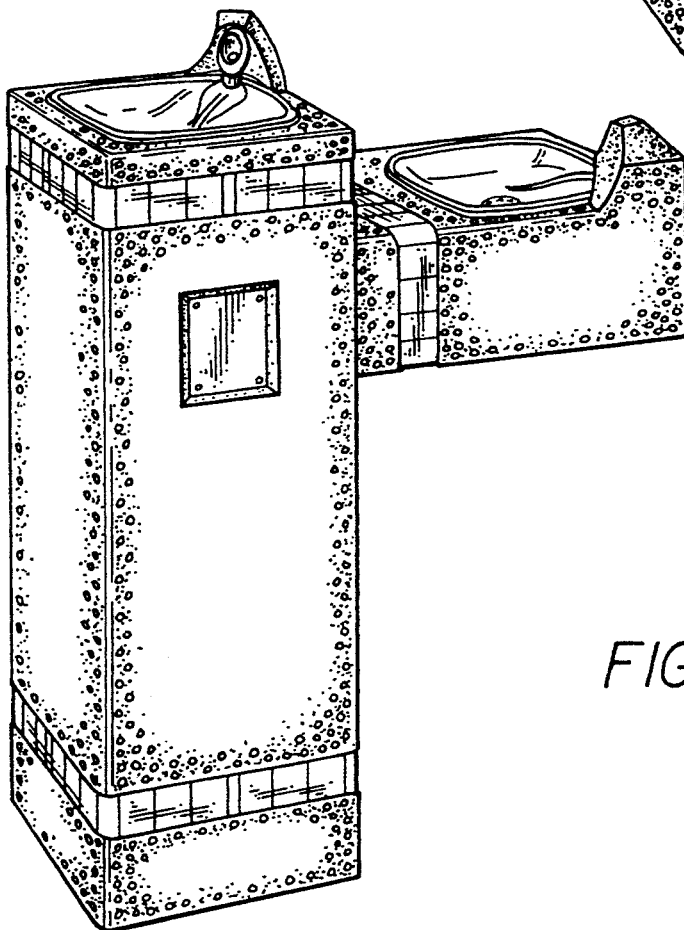
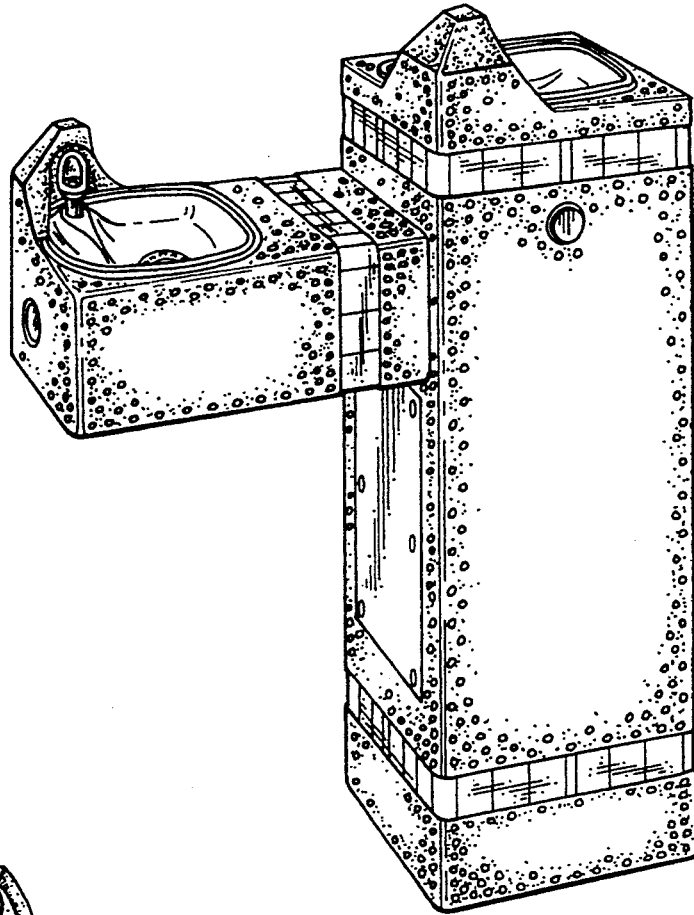

FIG. 9

FIG. 10

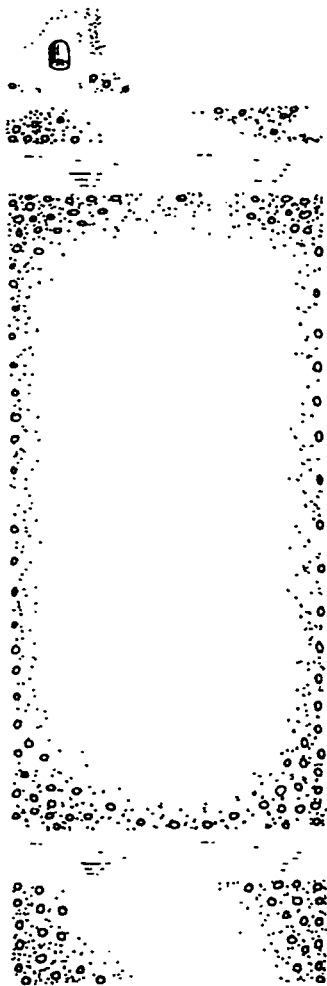
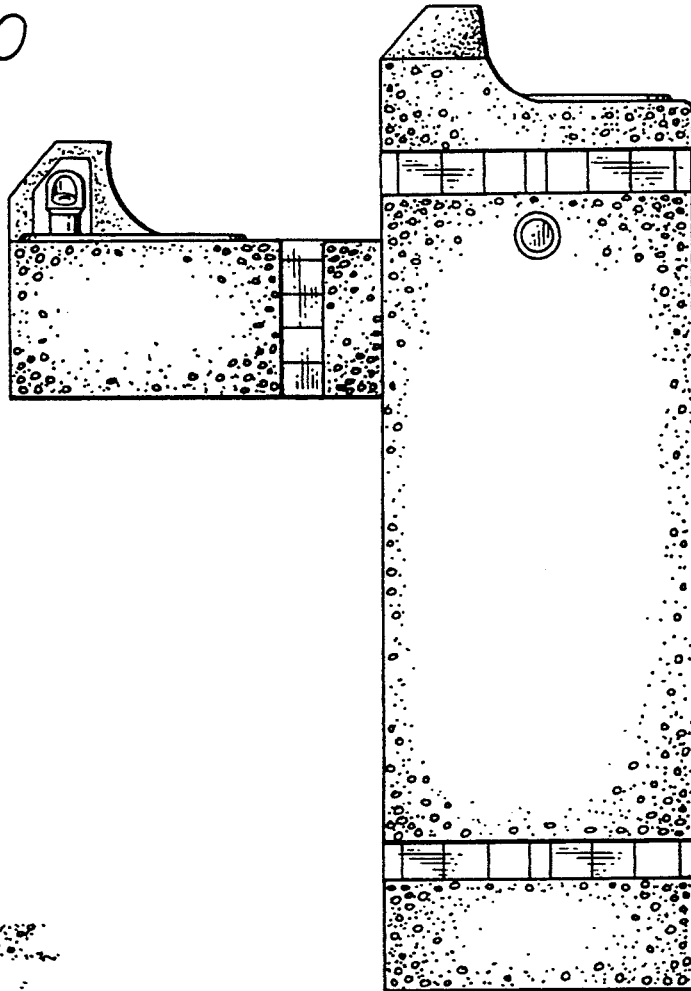

FIG. 11

FIG. 12

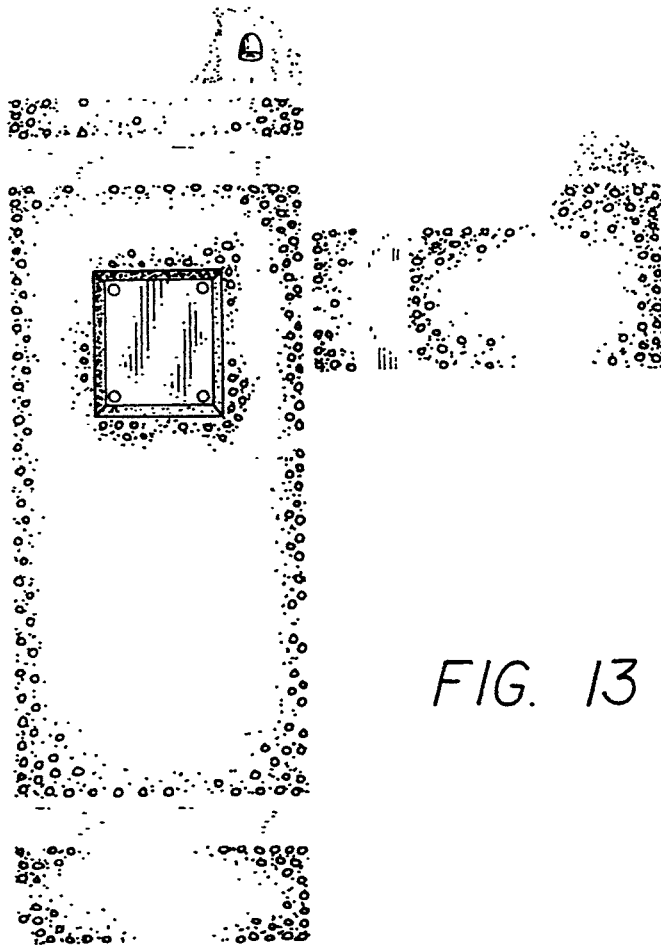
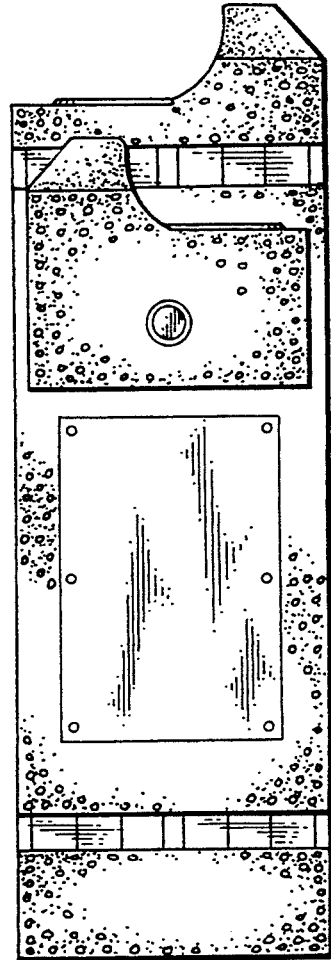

FIG. 13

FIG. 14

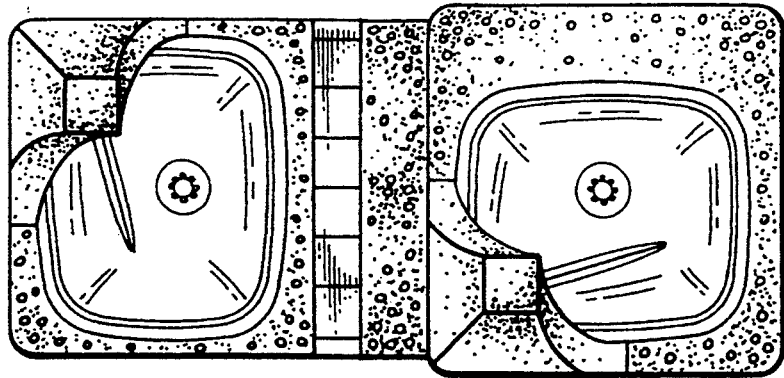
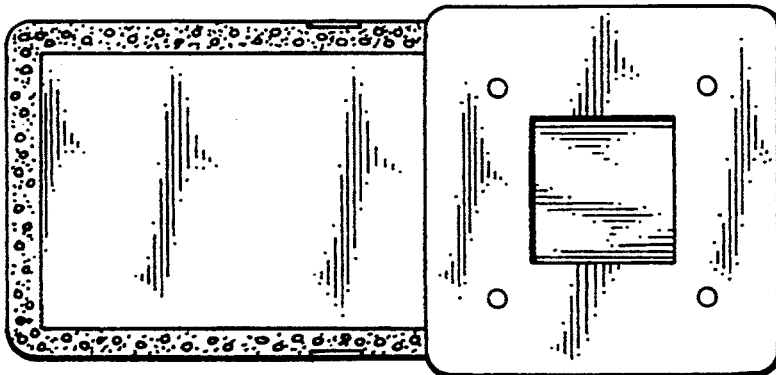

FIG. 15





UNITED STATES PATENT AND TRADEMARK OFFICE  
**CERTIFICATE OF CORRECTION**

PATENT NO. : Des.356,229  
DATED : March 14, 1995  
INVENTOR(S) : Matthew I. Stein

It is certified that error appears in the above-identified patent and that said Letters Patent is hereby corrected as shown below:

On the title page, item [73]  
Assignee, change "Nebr." to --Nev.--.

Signed and Sealed this  
Sixth Day of June, 1995



Attest:

BRUCE LEHMAN

Attesting Officer

Commissioner of Patents and Trademarks